

Cloud Setup & Cell Activation

(For faster setup, we recommend doing this step first)

1. Register or login to your account at: www.ControlByWeb.cloud
2. Choose 'Devices' from the left navigation bar and click 'New Device'.
3. On the New Device page, select the 'Cell Device' tab.
4. Enter a device name, the last 6 digits of serial number, and the Cell ID (located on the side of the device) and click 'Submit'.
5. You'll be redirected to the Device Edit page. *Click 'Activate SIM Card'.

**Note: If data plan was purchased separately, first enter Data Plan Code (sent via email) & click 'Apply Data Plan'. Activation may take 15 minutes. Click 'Check SIM Status' to verify activation.*

6. Once activated, power up the X-400C.
May take up to 5 minutes to connect.

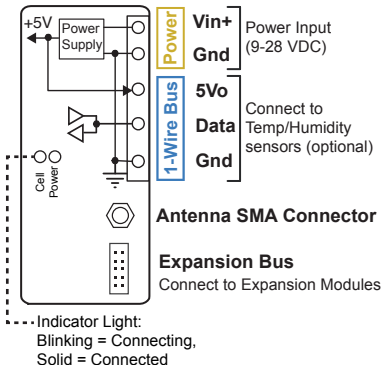

See users manual for setup instructions:
www.ControlByWeb.com/support/

LAN Setup Steps (Optional)

1. Power the module and connect to network.
2. Set IP address on computer to be on the same network as the module. (Example: Set computer to 192.168.1.50)
3. To configure the module, open a web browser and enter:
`http://192.168.1.2/setup.html`
4. Assign permanent IP address to module, then restart module.
5. Restore computer's IP address, if necessary, and access the module at its new IP address to finish setup.

Factory Default Settings

IP Address: 192.168.1.2

Subnet Mask: 255.255.255.0

Control Page Web Address: `http://192.168.1.2`

Control Password: *(no password set)*

Setup Page Web Address: `http://192.168.1.2/setup.html`

Setup Username: admin

Setup Password: webrelay *(all lower case)*

Warning: *The max number of attached expansion modules is determined by power supply voltage and current, and type of modules attached. For some installations, additional power supplies and expansion bus power injectors may be required.*

